

Die klassische und am weitesten verbreitete Verschraubungsserie im Rohrleitungsbau. Die Teile zeichnen sich durch eine hohe mechanische Beanspruchbarkeit und durch eine Oberflächengüte nach DIN 2444 aus.

Die Teile sind vollkommen mit einer Reinzinkschicht überzogen und somit trinkwassergeeignet, sowie gegen Rost geschützt.

Die Teile finden Verwendung im Rohrleitungsbau, bei der Sanitär- und Gasinstallation, sowie in einer Vielzahl von industriellen Anwendungen.

Maximaler Einsatzbereich bei Minustemperaturen = -20 °C; 25 bar.

Zulässiger Betriebsdruck bei Temperaturen zwischen -20 °C und 120 °C = 25 bar.

Zulässiger Betriebsdruck bei Temperaturen zwischen 120 °C und 300 °C = 20-25 bar.

Bei Produkten mit Flachdichtung ist ein eingeschränkter Temperatur-Bereich von -20 °C bis 200 °C bei max. 25 bar zu berücksichtigen.

Material: schwarzer Temperguss B350-10 Design Symbol A
 Temperaturbereich: -20 °C bis +300 °C (bei 20 bar)
 Oberfläche: feuerverzinkt
 Anschlussgewinde: nach ISO 7-1

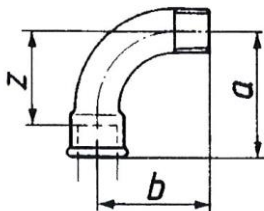

TFB 1-12

Bogen 1, lang, 90°, IG/AG

Typen Nr.	Artikel Nr.	Gewinde innen	Gewinde außen	a mm	b mm	z mm
TFB 1-14	112826	Rp 1/4	R 1/4	40,0	36,0	30,0
TFB 1-38	112827	Rp 3/8	R 3/8	48,0	42,0	38,0
TFB 1-12	112828	Rp 1/2	R 1/2	55,0	48,0	42,0
TFB 1-34	112829	Rp 3/4	R 3/4	69,0	60,0	54,0
TFB 1-10	112830	Rp 1	R 1	85,0	75,0	68,0
TFB 1-114	112831	Rp 1 1/4	R 1 1/4	105,0	95,0	86,0
TFB 1-112	112832	Rp 1 1/2	R 1 1/2	116,0	105,0	97,0
TFB 1-20	112833	Rp 2	R 2	140,0	130,0	116,0
TFB 1-212	112834	Rp 2 1/2	R 2 1/2	176,0	165,0	149,0
TFB 1-30	112835	Rp 3	R 3	205,0	190,0	175,0

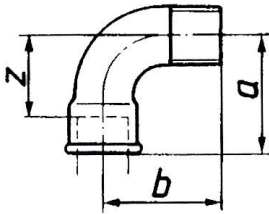

TFB 1A-12

Bogen 1a, kurz, 90°, IG/AG

Typen Nr.	Artikel Nr.	Gewinde innen	Gewinde außen	a mm	b mm	z mm
TFB 1A-14	112836	Rp 1/4	R 1/4	30,0	30,0	20,0
TFB 1A-38	112837	Rp 3/8	R 3/8	36,0	36,0	26,0
TFB 1A-12	112838	Rp 1/2	R 1/2	45,0	45,0	32,0
TFB 1A-34	112839	Rp 3/4	R 3/4	50,0	50,0	35,0
TFB 1A-10	112840	Rp 1	R 1	63,0	63,0	46,0
TFB 1A-114	112841	Rp 1 1/4	R 1 1/4	76,0	76,0	57,0
TFB 1A-112	112842	Rp 1 1/2	R 1 1/2	85,0	85,0	66,0
TFB 1A-20	112843	Rp 2	R 2	102,0	102,0	78,0
TFB 1A-212	112844	Rp 2 1/2	R 2 1/2	-	-	-

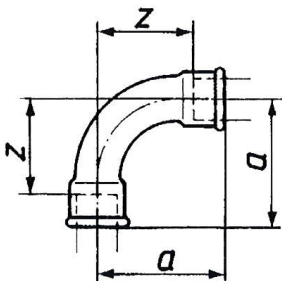

TFB 2-12

Bogen 2, lang, 90°, IG/IG

Typen Nr.	Artikel Nr.	Gewinde innen	a mm	z mm
TFB 2-14	112845	Rp/Rp 1/4	40,0	30,0
TFB 2-38	112846	Rp/Rp 3/8	48,0	38,0
TFB 2-12	112847	Rp/Rp 1/2	55,0	42,0
TFB 2-34	112848	Rp/Rp 3/4	69,0	54,0
TFB 2-10	112849	Rp/Rp 1	85,0	68,0
TFB 2-114	112850	Rp/Rp 1 1/4	105,0	86,0
TFB 2-112	112851	Rp/Rp 1 1/2	116,0	97,0
TFB 2-20	112852	Rp/Rp 2	140,0	116,0
TFB 2-212	112853	Rp 2 1/2	176,0	149,0
TFB 2-30	112854	Rp 3	205,0	175,0

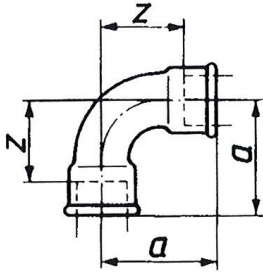

TFB 2A-10

Bogen 2a, kurz, 90°, IG/IG

Typen Nr.	Artikel Nr.	Gewinde innen	a mm	z mm
TFB 2A-14	112855	Rp/Rp 1/4	30,0	20,0
TFB 2A-38	112856	Rp/Rp 3/8	36,0	26,0
TFB 2A-12	112857	Rp/Rp 1/2	45,0	32,0
TFB 2A-34	112858	Rp/Rp 3/4	50,0	35,0
TFB 2A-10	112859	Rp/Rp 1	63,0	46,0
TFB 2A-114	112860	Rp/Rp 1 1/4	76,0	57,0
TFB 2A-112	112861	Rp/Rp 1 1/2	85,0	66,0
TFB 2A-20	112862	Rp/Rp 2	102,0	78,0

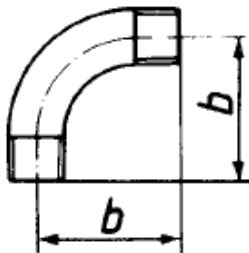
Bogen 3, lang, 90°, AG/AG

TFB 3-34

Typen Nr.	Artikel Nr.	Gewinde innen	b mm
TFB 3-38	112863	R 3/8	42,0
TFB 3-12	112864	R 1/2	48,0
TFB 3-34	112865	R 3/4	60,0
TFB 3-10	112866	R 1	75,0
TFB 3-114	112867	R 1 1/4	95,0
TFB 3-112	112868	R 1 1/2	105,0
TFB 3-20	112869	R 2	130,0

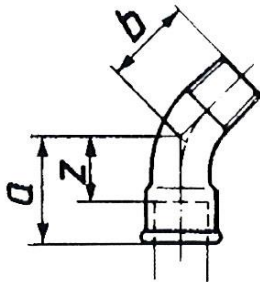

TFB 40-10

Bogen 40, 45°, IG/AG

Typen Nr.	Artikel Nr.	Gewinde innen	Gewinde außen	a mm	b mm	z mm
TFB 40-14	112870	Rp 1/4	R 1/4	26,0	21,0	16,0
TFB 40-38	112871	Rp 3/8	R 3/8	30,0	24,0	20,0
TFB 40-12	112872	Rp 1/2	R 1/2	36,0	30,0	23,0
TFB 40-34	112873	Rp 3/4	R 3/4	43,0	36,0	28,0
TFB 40-10	112874	Rp 1	R 1	51,0	42,0	34,0
TFB 40-114	112875	Rp 1 1/4	R 1 1/4	64,0	54,0	45,0
TFB 40-112	112876	Rp 1 1/2	R 1 1/2	68,0	58,0	49,0
TFB 40-20	112877	Rp 2	R 2	81,0	70,0	57,0
TFB 40-212	112878	Rp 2 1/2	R 2 1/2	99,0	86,0	72,0
TFB 40-30	112879	Rp 3	R 3	113,0	100,0	83,0

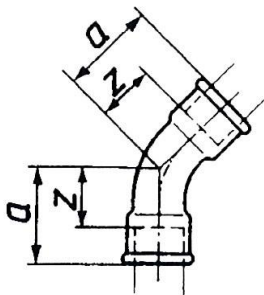

TFB 41-10

Bogen 41, 45°, IG/IG

Typen Nr.	Artikel Nr.	Gewinde innen	a mm	z mm
TFB 41-38	112880	Rp/Rp 3/8	30,0	20,0
TFB 41-12	112881	Rp/Rp 1/2	36,0	23,0
TFB 41-34	112882	Rp/Rp 3/4	43,0	28,0
TFB 41-10	112883	Rp/Rp 1	51,0	34,0
TFB 41-114	112884	Rp/Rp 1 1/4	64,0	45,0
TFB 41-112	112885	Rp/Rp 1 1/2	68,0	49,0
TFB 41-20	112886	Rp/Rp 2	81,0	57,0
TFB 41-212	112887	Rp/Rp 2 1/2	99,0	72,0
TFB 41-30	112888	Rp/Rp 3	113,0	83,0

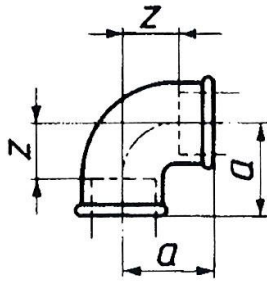

TFW 90-12

Winkel 90, 90°, IG/IG

Typen Nr.	Artikel Nr.	Gewinde innen	a mm	z mm
TFW 90-14	112889	Rp/Rp 1/4	21,0	11,0
TFW 90-38	112890	Rp/Rp 3/8	25,0	15,0
TFW 90-12	112891	Rp/Rp 1/2	28,0	15,0
TFW 90-34	112892	Rp/Rp 3/4	33,0	18,0
TFW 90-10	112893	Rp/Rp 1	38,0	21,0
TFW 90-114	112894	Rp/Rp 1 1/4	45,0	26,0
TFW 90-112	112895	Rp/Rp 1 1/2	50,0	31,0
TFW 90-20	112896	Rp/Rp 2	58,0	34,0
TFW 90-212	112897	Rp/Rp 2 1/2	69,0	42,0
TFW 90-30	112898	Rp/Rp 3	78,0	48,0

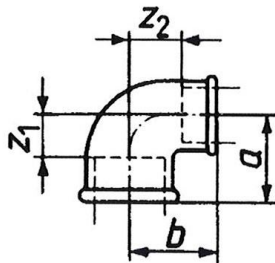

TFW 90-1012

Winkel 90, 90°, reduzierend, IG/IG

Typen Nr.	Artikel Nr.	Gewinde innen	Gewinde innen	a mm	b mm	c mm	z ₁ mm	z ₂ mm
TFW 90-1238	133560	Rp 1/2	Rp 3/8	26,0	26,0	33,0	13,0	16,0
TFW 90-3412	133561	Rp 3/4	Rp 1/2	30,0	31,0	40,0	15,0	18,0
TFW 90-1012	133562	Rp 1	Rp 1/2	32,0	34,0	-	15,0	21,0
TFW 90-1034	133563	Rp 1	Rp 3/4	35,0	36,0	46,0	18,0	21,0
TFW 90-11410	133564	Rp 1 1/4	Rp 1	40,0	42,0	56,0	21,0	25,0
TFW 90-11212	133565	Rp 1 1/2	Rp 1/2	-	-	-	-	-
TFW 90-112114	133566	Rp 1 1/2	Rp 1 1/4	46,0	48,0	-	27,0	29,0
TFW 90-21	133567	Rp 2	Rp 1	-	-	-	-	-
TFW 90-212112	133568	Rp 2 1/2	Rp 1 1/2	-	-	-	-	-

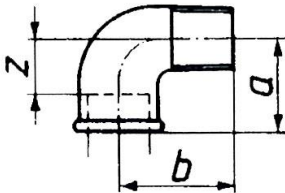

TFW 92-12

Winkel 92, 90°, IG/AG

Typen Nr.	Artikel Nr.	Gewinde innen	Gewinde außen	a mm	b mm	z mm
TFW 92-14	112899	Rp 1/4	R 1/4	21,0	28,0	11,0
TFW 92-38	112900	Rp 3/8	R 3/8	25,0	32,0	15,0
TFW 92-12	112901	Rp 1/2	R 1/2	28,0	37,0	15,0
TFW 92-34	112902	Rp 3/4	R 3/4	33,0	43,0	18,0
TFW 92-10	112903	Rp 1	R 1	38,0	52,0	21,0
TFW 92-114	112904	Rp 1 1/4	R 1 1/4	45,0	60,0	26,0
TFW 92-112	112905	Rp 1 1/2	R 1 1/2	50,0	65,0	31,0
TFW 92-20	112906	Rp 2	R 2	58,0	74,0	34,0
TFW 92-212	112907	Rp 2 1/2	R 2 1/2	69,0	88,0	42,0
TFW 92-30	112908	Rp 3	R 3	78,0	98,0	48,0

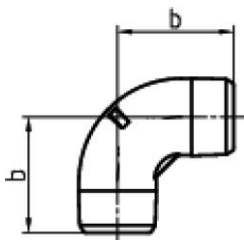

TFW 94-38

Winkel 94, 90°, AG/AG

Typen Nr.	Artikel Nr.	Gewinde außen	b mm
TFW 94-38	112909	R/R 3/8	30,0
TFW 94-12	112910	R/R 1/2	37,0
TFW 94-34	112911	R/R 3/4	40,0
TFW 94-10	112912	R/R 1	47,0
TFW 94-114	112913	R/R 1 1/4	57,0
TFW 94-112	112914	R/R 1 1/2	60,0
TFW 94-20	112915	R/R 2	70,0

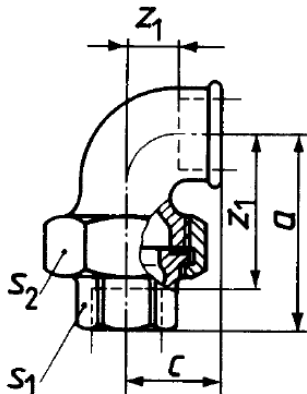

TFV 95-10

Verschraubung Bogen 95, flach dichtend, IG/IG, ohne Dichtung
 Temperaturbereich -20 °C bis 200 °C

Typen Nr.	Artikel Nr.	Gewinde innen	a mm	b mm	c mm	z ₁ mm
TFV 95-12	112916	Rp 1/2	58,0	76,0	28,0	15,0
TFV 95-34	112917	Rp 3/4	62,0	82,0	33,0	18,0
TFV 95-10	112918	Rp 1	72,0	94,0	38,0	21,0
TFV 95-114	112919	Rp 1 1/4	82,0	107,0	45,0	26,0
TFV 95-112	112920	Rp 1 1/2	90,0	115,0	50,0	31,0
TFV 95-20	112921	Rp 2	100,0	128,0	58,0	34,0

→ Maximale Temperatur und maximaler Betriebsdruck dürfen nicht gleichzeitig auftreten!

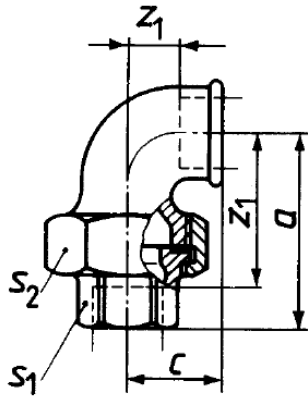

TFV 96-10

Verschraubung Bogen 96, konisch dichtend, IG/IG

Typen Nr.	Artikel Nr.	Gewinde innen	a mm	b mm	z ₁ mm
TFV 96-12	112922	Rp 1/2	58,0	76,0	15,0
TFV 96-34	112923	Rp 3/4	62,0	82,0	18,0
TFV 96-10	112924	Rp 1	72,0	94,0	21,0
TFV 96-114	112925	Rp 1 1/4	82,0	107,0	26,0
TFV 96-112	112926	Rp 1 1/2	90,0	115,0	31,0
TFV 96-20	112927	Rp 2	100,0	128,0	34,0
TFV 96-212	112928	Rp 2 1/2	-	-	-

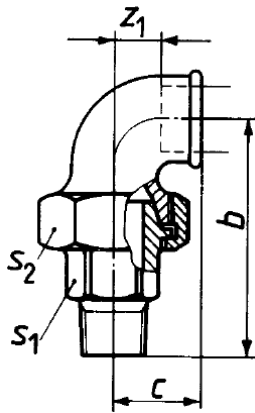

TFV 98-10

Verschraubung Bogen 97, flach dichtend, IG/AG, ohne Dichtung
 Temperaturbereich -20 °C bis 200 °C

Typen Nr.	Artikel Nr.	Gewinde 1 außen	Gewinde 2 außen	b mm	c mm	z ₁ mm
TFV 97-12	112929	Rp 1/2	R 1/2	76,0	28,0	15,0
TFV 97-34	112930	Rp 3/4	R 3/4	82,0	33,0	18,0
TFV 97-10	112931	Rp 1	R 1	94,0	38,0	21,0
TFV 97-114	112932	Rp 1 1/4	R 1 1/4	45,0	45,0	26,06
TFV 97-112	112933	Rp 1 1/2	R 1 1/2	115,0	50,0	31,0
TFV 97-20	112934	Rp 2	R 2	128,0	58,0	34,0

→ Maximale Temperatur und maximaler Betriebsdruck dürfen nicht gleichzeitig auftreten!

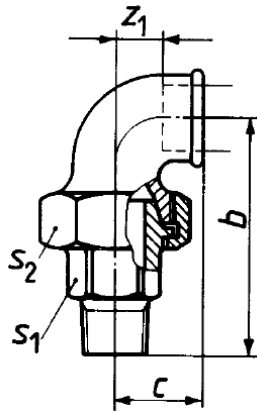

TFV 98-10

Verschraubung Bogen 98, konisch dichtend, IG/AG

Typen Nr.	Artikel Nr.	Gewinde 1 außen	Gewinde 2 außen	b mm	c mm	z ₁ mm
TFV 98-14	112935	Rp 1/4	R 1/4	61,0	21,0	11,0
TFV 98-12	112936	Rp 1/2	R 1/2	76,0	28,0	15,0
TFV 98-34	112937	Rp 3/4	R 3/4	82,0	33,0	18,0
TFV 98-10	112938	Rp 1	R 1	94,0	38,0	21,0
TFV 98-114	112939	Rp 1 1/4	R 1 1/4	107,0	45,0	26,0
TFV 98-112	112940	Rp 1 1/2	R 1 1/2	115,0	50,0	31,0
TFV 98-20	112941	Rp 2	R 2	128,0	58,0	34,0
TFV 98-212	112942	Rp 2 1/2	R 2 1/2	-	-	-

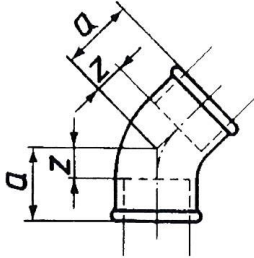

TFW 120-12

Winkel 120, 45°, IG/IG

Typen Nr.	Artikel Nr.	Gewinde innen	a mm	z mm
TFW 120-38	112943	Rp/Rp /3/8	20,0	10,0
TFW 120-12	112944	Rp/Rp 1/2	22,0	9,0
TFW 120-34	112945	Rp/Rp 3/4	25,0	10,0
TFW 120-10	112946	Rp/Rp 1	28,0	11,0
TFW 120-114	112947	Rp/Rp 1 1/4	33,0	14,0
TFW 120-112	112948	Rp/Rp 1 1/2	36,0	17,0
TFW 120-20	112949	Rp/Rp 2	43,0	19,0
TFW 120-212	112950	Rp 2 1/2	-	-
TFW 120-30	112951	Rp 3	-	-

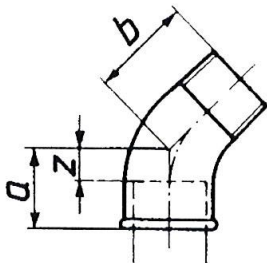

TFW 121-12

Winkel 121, 45°, IG/AG

Typen Nr.	Artikel Nr.	Gewinde innen	Gewinde außen	a mm	b mm	z mm
TFW 121-38	112952	Rp 3/8	R 3/8	20,0	25,0	10,0
TFW 121-12	112953	Rp 1/2	R 1/2	22,0	28,0	9,0
TFW 121-34	112954	Rp 3/4	R 3/4	25,0	32,0	10,0
TFW 121-10	112955	Rp 1	R 1	28,0	37,0	11,0
TFW 121-114	112956	Rp 1 1/4	R 1 1/4	33,0	43,0	14,0
TFW 121-112	112957	Rp 1 1/2	R 1 1/2	36,0	46,0	17,0
TFW 121-20	112958	Rp 2	R 2	43,0	55,0	19,0

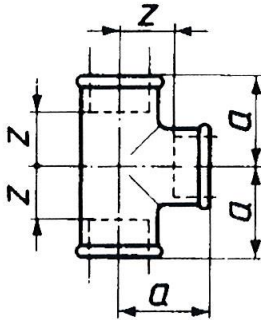

TFT 130-12

T-Stück 130, IG/IG/IG

Typen Nr.	Artikel Nr.	Gewinde innen	a mm	z mm
TFT 130-14	112959	Rp 1/4	21,0	11,0
TFT 130-38	112960	Rp 3/8	25,0	15,0
TFT 130-12	112961	Rp 1/2	28,0	15,0
TFT 130-34	112962	Rp 3/4	33,0	18,0
TFT 130-10	112963	Rp 1	38,0	21,0
TFT 130-114	112964	Rp 1 1/4	45,0	26,0
TFT 130-112	112965	Rp 1 1/2	50,0	31,0
TFT 130-20	112966	Rp 2	58,0	34,0
TFT 130-212	112967	Rp 2 1/2	69,0	42,0
TFT 130-30	112968	Rp 3	78,0	48,0

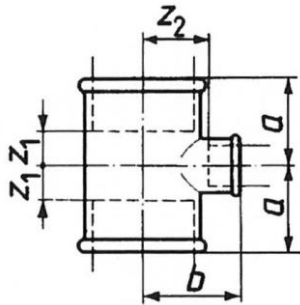

TFT 130-3438

T-Stück 130, reduzierend, IG/IG/IG

Typen Nr.	Artikel Nr.	Gewinde 1	Gewinde 2 T-Abzweig reduziert	a mm	b mm	z ₁ mm	z ₂ mm
TFT 130-3814	112969	Rp/Rp 3/8	Rp1/4	23,0	23,0	13,0	13,0
TFT 130-1214	112970	Rp/Rp 1/2	Rp 1/4	24,0	24,0	11,0	14,0
TFT 130-1238	112971	Rp/Rp 1/2	Rp 3/8	26,0	26,0	13,0	16,0
TFT 130-3414	125298	Rp/Rp 3/4	Rp 1/4	26,0	27,0	11,0	17,0
TFT 130-3438	112973	Rp/Rp 3/4	Rp 3/8	28,0	28,0	13,0	18,0
TFT 130-3412	112974	Rp/Rp 3/4	Rp 1/2	30,0	31,0	15,0	18,0
TFT 130-1038	112975	Rp/Rp 1	Rp 3/8	30,0	32,0	13,0	22,0
TFT 130-1012	112976	Rp/Rp 1	Rp 1/2	32,0	34,0	15,0	21,0
TFT 130-1034	112977	Rp/Rp 1	Rp 3/4	35,0	36,0	18,0	21,0
TFT 130-11438	125297	Rp/Rp 1 1/4	Rp 3/8	32,0	36,0	13,0	26,0
TFT 130-11412	112979	Rp/Rp 1 1/4	Rp 1/2	34,0	38,0	15,0	25,0
TFT 130-11434	112980	Rp/Rp 1 1/4	Rp 3/4	36,0	41,0	17,0	26,0
TFT 130-11410	112981	Rp/Rp 1 1/4	Rp 1	40,0	42,0	21,0	25,0
TFT 130-11238	125296	Rp/Rp 1 1/2	Rp 3/8	33,0	38,0	14,0	28,0
TFT 130-11212	112983	Rp/Rp 1 1/2	Rp 1/2	36,0	42,0	17,0	29,0
TFT 130-11234	112984	Rp/Rp 1 1/2	Rp 3/4	38,0	44,0	19,0	29,0
TFT 130-11210	112985	Rp/Rp 1 1/2	Rp 1	42,0	46,0	23,0	29,0
TFT130-112114	112986	Rp/Rp 1 1/2	Rp 1 1/4	46,0	48,0	27,0	29,0
TFT 130-2012	112987	Rp/Rp 2	Rp 1/2	38,0	48,0	14,0	35,0
TFT 130-2034	112988	Rp/Rp 2	Rp 3/4	40,0	50,0	16,0	35,0
TFT 130-2010	112989	Rp/Rp 2	Rp 1	44,0	52,0	20,0	35,0
TFT 130-20114	112990	Rp/Rp 2	Rp 1 1/4	48,0	54,0	24,0	35,0
TFT 130-20112	112991	Rp/Rp 2	Rp 1 1/2	52,0	55,0	28,0	36,0
TFT 130-21210	112992	Rp/Rp 2 1/2	Rp 1	47,0	60,0	20,0	43,0
TFT130-212114	112993	Rp/Rp 2 1/2	Rp 1 1/4	52,0	62,0	25,0	43,0
TFT130-212112	112994	Rp/Rp 2 1/2	Rp 1 1/2	55,0	63,0	28,0	44,0
TFT 130-21220	112995	Rp/Rp 2 1/2	Rp 2	61,0	66,0	34,0	42,0
TFT 130-3020	112996	Rp/Rp 3	Rp 2	64,0	73,0	34,0	49,0
TFT 130-30212	112997	Rp/Rp 3	Rp 1 1/2	58,0	71,0	28,0	52,0

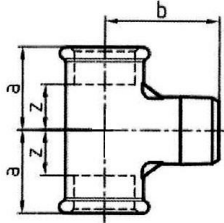

TFT 133-38

T-Stück 133, IG/AG/IG

Typen Nr.	Artikel Nr.	Gewinde	a mm	b mm	z mm
TFT 133-38	112998	Rp 3/8	22	31	12
TFT 133-12	112999	Rp 1/2	25	38	12
TFT 133-10	113000	Rp 1	39	53	22



TFT 134-10

T-Stück 134, IG/IG/AG

Typen Nr.	Artikel Nr.	Gewinde1	Gewinde2	Gewinde3
TFT 134-12	113001	Rp 1/2	R 1/2	Rp 1/2
TFT 134-34	113002	Rp 3/4	R 3/4	Rp 3/4
TFT 134-10	113003	Rp 1	R 1	Rp 1
TFT 134-114	113004	Rp 1 1/4	R 1 1/4	Rp 1 1/4
TFT 134-112	113005	Rp 1 1/2	R 1 1/2	Rp 1 1/2
TFT 134-20	113006	Rp 2	R 2	Rp 2

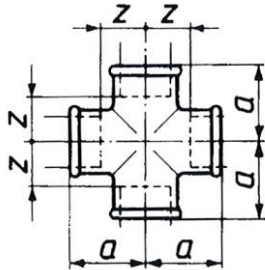

TFK 180-12

Kreuzstück 180, 4 x IG

Typen Nr.	Artikel Nr.	Gewinde innen	a mm	z mm
TFK 180-14	113007	Rp 1/4	21,0	11,0
TFK 180-38	113008	Rp 3/8	25,0	15,0
TFK 180-12	113009	Rp 1/2	28,0	15,0
TFK 180-34	113010	Rp 3/4	33,0	18,0
TFK 180-10	113011	Rp 1	38,0	21,0
TFK 180-114	113012	Rp 1 1/4	45,0	26,0
TFK 180-112	113013	Rp 1 1/2	50,0	31,0
TFK 180-20	113014	Rp 2	58,0	34,0
TFK 180-30	113015	Rp 3	78,0	48,0

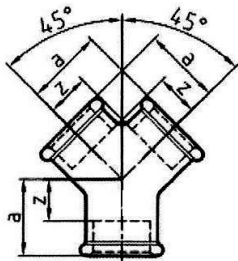

TFY 220-10

Y-Stück 220, IG/IG/IG

Typen Nr.	Artikel Nr.	Gewinde innen	a mm	z mm
TFY 220-12	113016	Rp 1/2	27,0	14,0
TFY 220-34	113017	Rp 3/4	33,0	18,0
TFY 220-10	113018	Rp 1	40,0	23,0

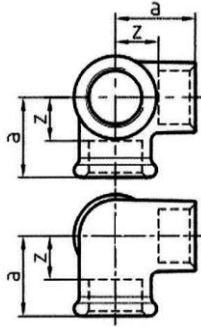

TFE 221-10

Winkelverteiler 221, IG/IG/IG

Typen Nr.	Artikel Nr.	Gewinde innen	a mm	z mm
TFE 221-12	113019	Rp 1/2	28,0	15,0
TFE 221-34	113020	Rp 3/4	33,0	18,0
TFE 221-10	113021	Rp 1	38,0	21,0
TFE 221-112	113022	Rp 1 1/2	50,0	31,0
TFE 221-20	113023	Rp 2	58,0	34,0

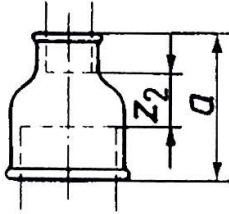

TFM 240-1012

Muffe 240, reduzierend, IG/IG

Typen Nr.	Artikel Nr.	Gewinde 1 innen	Gewinde 2 innen	a mm	z ₂ mm
TFM 240-3814	113024	Rp 3/8	Rp 1/4	30,0	10,0
TFM 240-1214	113025	Rp 1/2	Rp 1/4	36,0	13,0
TFM 240-1238	113026	Rp 1/2	Rp 3/8	36,0	13,0
TFM 240-3414	113027	Rp 3/4	Rp 1/4	39,0	14,0
TFM 240-3438	113028	Rp 3/4	Rp 3/8	39,0	14,0
TFM 240-3412	113029	Rp 3/4	Rp 1/2	38,0	11,0
TFM 240-1038	113030	Rp 1	Rp 3/8	45,0	18,0
TFM 240-1012	113031	Rp 1	Rp 1/2	45,0	15,0
TFM 240-1034	113032	Rp 1	Rp 3/4	45,0	13,0
TFM 240-11438	125295	Rp 1 1/4	Rp 3/8	50,0	21,0
TFM 240-11412	113034	Rp 1 1/4	Rp 1/2	50,0	18,0
TFM 240-11434	113035	Rp 1 1/4	Rp 3/4	50,0	16,0
TFM 240-11410	113036	Rp 1 1/4	Rp 1	50,0	14,0
TFM 240-11212	113037	Rp 1 1/2	Rp 1/2	55,0	23,0
TFM 240-11234	113038	Rp 1 1/2	Rp 3/4	55,0	21,0
TFM 240-11210	113039	Rp 1 1/2	Rp 1	55,0	19,0
TFM240-112114	113040	Rp 1 1/2	Rp 1 1/4	55,0	17,0
TFM 240-2012	113041	Rp 2	Rp 1/2	65,0	28,0
TFM 240-2034	113042	Rp 2	Rp 3/4	65,0	26,0
TFM 240-2010	113043	Rp 2	Rp 1	65,0	24,0
TFM 240-20114	113044	Rp 2	Rp 1 1/4	65,0	22,0
TFM 240-20112	113045	Rp 2	Rp 1 1/2	65,0	22,0
TFM 240-21220	113046	Rp 2 1/2	Rp 2	74,0	23,0
TFM 240-30112	113047	Rp 3	Rp 1 1/2	80,0	31,0
TFM 240-3020	113048	Rp 3	Rp 2	80,0	26,0
TFM 240-30212	113049	Rp 3	Rp 2 1/2	80,0	23,0

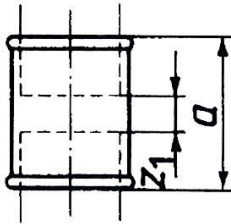

TFM 270-12

Muffe 270, IG/IG

Typen Nr.	Artikel Nr.	Gewinde innen	a mm	z ₁ mm
TFM 270-14	113050	Rp/Rp 1/4	27,0	7,0
TFM 270-38	113051	Rp/Rp 3/8	30,0	10,0
TFM 270-12	113052	Rp/Rp 1/2	36,0	10,0
TFM 270-34	113053	Rp/Rp 3/4	39,0	9,0
TFM 270-10	113054	Rp/Rp 1	45,0	11,0
TFM 270-114	113055	Rp/Rp 1 1/4	50,0	12,0
TFM 270-112	113056	Rp/Rp 1 1/2	50,0	17,0
TFM 270-20	113057	Rp/Rp 2	65,0	17,0
TFM 270-212	113058	Rp 2 1/2	74,0	20,0
TFM 270-30	113059	Rp 3	80,0	20,0

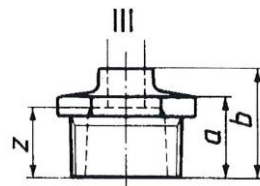
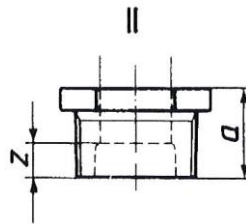
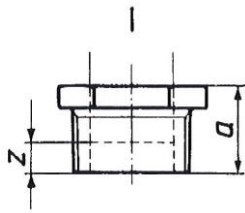

TFR 241-1214

Reduzierstück 241, AG/IG

Typen Nr.	Artikel Nr.	Gewinde 1 außen	Gewinde 2 innen	a mm	b mm	z mm	Form
TFR 241-3814	113060	R 3/8	Rp 1/4	20,0	-	10,0	I
TFR 241-1214	113061	R 1/2	Rp 1/4	24,0	-	14,0	II
TFR 241-1238	113062	R 1/2	Rp 3/8	24,0	-	14,0	I
TFR 241-3414	113063	R 3/4	Rp 1/4	26,0	-	16,0	II
TFR 241-3438	113064	R 3/4	Rp 3/8	26,0	-	16,0	II
TFR 241-3412	113065	R 3/4	Rp 1/2	26,0	-	13,0	I
TFR 241-1038	113066	R 1	Rp 3/8	29,0	-	19,0	II
TFR 241-1012	113067	R 1	Rp 1/2	29,0	-	16,0	II
TFR 241-1034	113068	R 1	Rp 3/4	29,0	-	14,0	I
TFR 241-11438	113069	R 1 1/4	Rp 3/8	31,0	-	21,0	II
TFR 241-11412	113070	R 1 1/4	Rp 1/2	31,0	-	18,0	II
TFR 241-11434	113071	R 1 1/4	Rp 3/4	31,0	-	16,0	II
TFR 241-11410	113072	R 1 1/4	Rp 1	31,0	-	14,0	I
TFR 241-11238	113073	R 1 1/2	Rp 3/8	31,0	-	21,0	II
TFR 241-11212	113074	R 1 1/2	Rp 1/2	31,0	-	18,0	II
TFR 241-11234	113075	R 1 1/2	Rp 3/4	31,0	-	16,0	II
TFR 241-11210	113076	R 1 1/2	Rp 1	31,0	-	14,0	II
TFR241-112114	113077	R 1 1/2	Rp 1 1/4	31,0	-	12,0	I
TFR 241-2012	113078	R 2	Rp 1/2	35,0	48,0	35,0	III
TFR 241-2034	113079	R 2	Rp 3/4	35,0	48,0	33,0	III
TFR 241-2010	113080	R 2	Rp 1	35,0	-	18,0	II
TFR 241-20114	113081	R 2	Rp 1 1/4	35,0	-	16,0	II
TFR 241-20112	113082	R 2	Rp 1 1/2	35,0	-	16,0	II
TFR241-212112	113083	R 2 1/2	Rp 1 1/2	40,0	-	21,0	II
TFR 241-21220	113084	R 2 1/2	Rp 2	40,0	-	16,0	II
TFR 241-30112	113085	R 3	Rp 1 1/2	44,0	59,0	40,0	III
TFR 241-3020	113086	R 3	Rp 2	44,0	-	20,0	II
TFR 241-30212	113087	R 3	Rp 2 1/2	44,0	-	17,0	II

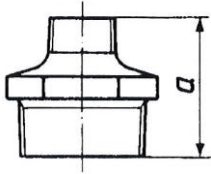

TFD 245-1238

Doppelnippel 245, reduzierend, AG/AG

Typen Nr.	Artikel Nr.	Gewinde 1 außen	Gewinde 2 außen	a mm
TFD 245-3814	113088	R 3/8	R 1/4	38,0
TFD 245-1214	113089	R 1/2	R 1/4	44,0
TFD 245-1238	113090	R 1/2	R 3/8	44,0
TFD 245-3438	113091	R 3/4	R 3/8	47,0
TFD 245-3412	113092	R 3/4	R 1/2	47,0
TFD 245-1012	113093	R 1	R 1/2	53,0
TFD 245-1034	113094	R 1	R 3/4	53,0
TFD 245-11434	113095	R 1 1/4	R 3/4	57,0
TFD 245-11410	113096	R 1 1/4	R 1	57,0
TFD 245-11212	133569	R 1 1/2	R 1/2	-
TFD 245-11234	133570	R 1 1/2	R 3/4	59,0
TFD 245-11210	113097	R 1 1/2	R 1	59,0
TFD245-112114	113098	R 1 1/2	R 1 1/4	59,0
TFD 245-234	133571	R 2	R 3/4	-
TFD 245-20114	113099	R 2	R 1 1/4	68,0
TFD 245-20112	113100	R 2	R 1 1/2	68,0
TFD245-212112	113101	R 2 1/2	R 1 1/2	75,0
TFD 245-21220	113102	R 2 1/2	R 2	75,0
TFD 245-3020	113103	R 3	R 2	83,0
TFD 245-30212	113104	R 3	R 2 1/2	83,0

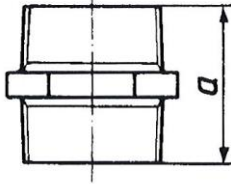

TFD 280-12

Doppelnippel 280, AG/AG

Typen Nr.	Artikel Nr.	Gewinde außen	a mm
TFD 280-14	113105	R 1/4	36,0
TFD 280-38	113106	R 3/8	38,0
TFD 280-12	113107	R 1/2	44,0
TFD 280-34	113108	R 3/4	47,0
TFD 280-10	113109	R 1	53,0
TFD 280-114	113110	R 1 1/4	57,0
TFD 280-112	113111	R 1 1/2	59,0
TFD 280-20	113112	R 2	68,0
TFD 280-212	113113	R 2 1/2	-
TFD 280-30	113114	R 3	-

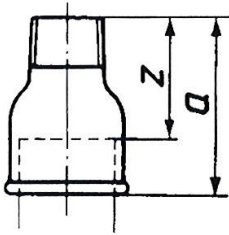

TFM 246-1012

Reduziermuffe 246, IG/AG

Typen Nr.	Artikel Nr.	Gewinde 1 innen	Gewinde 2 außen	a mm	z mm
TFM 246-3814	113115	Rp 3/8	R 1/4	35,0	25,0
TFM 246-1214	113116	Rp 1/2	R 1/4	43,0	30,0
TFM 246-1238	113117	Rp 1/2	R 3/8	43,0	30,0
TFM 246-3412	113118	Rp 3/4	R 1/2	48,0	33,0
TFM 246-1012	113119	Rp 1	R 1/2	55,0	38,0
TFM 246-1034	113120	Rp 1	R 3/4	55,0	38,0
TFM 246-11434	113121	Rp 1 1/4	R 3/4	60,0	41,0
TFM 246-11410	113122	Rp 1 1/4	R 1	60,0	41,0
TFM 246-11210	113123	Rp 1 1/2	R 1	63,0	44,0
TFM246-112114	113124	Rp 1 1/2	R 1 1/4	63,0	44,0
TFM 246-2010	113125	Rp 2	R 1	65,0	43,0
TFM 246-20114	113126	Rp 2	R 1 1/4	70,0	46,0
TFM 246-20112	113127	Rp 2	R 1 1/2	70,0	46,0
TFM 246-21220	113128	Rp 2 1/2	R 2	-	-
TFM 246-3020	113129	Rp 3	R 2	-	-
TFM 246-30212	113130	Rp 3	R 2 1/2	-	-

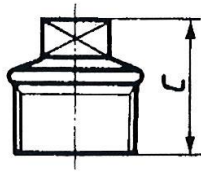

TFS 290-10

Stopfen 290, AG

Typen Nr.	Artikel Nr.	Gewinde außen	c min. mm
TFS 290-14	113131	R 1/4	22,0
TFS 290-38	113132	R 3/8	24,0
TFS 290-12	113133	R 1/2	26,0
TFS 290-34	113134	R 3/4	32,0
TFS 290-10	113135	R 1	36,0
TFS 290-114	113136	R 1 1/4	39,0
TFS 290-112	113137	R 1 1/2	41,0
TFS 290-20	113138	R 2	48,0
TFS 290-212	113139	R 2 1/2	54,0
TFS 290-30	113140	R 3	60,0



TFK 300-12

Kappe 300, IG

Typen Nr.	Artikel Nr.	Gewinde innen	a min. mm
TFK 300-14	113141	Rp 1/4	15,0
TFK 300-38	113142	Rp 3/8	17,0
TFK 300-12	113143	Rp 1/2	19,0
TFK 300-34	113144	Rp 3/4	22,0
TFK 300-10	113145	Rp 1	24,0
TFK 300-114	113146	Rp 1 1/4	27,0
TFK 300-112	113147	Rp 1 1/2	27,0
TFK 300-20	113148	Rp 2	32,0
TFK 300-212	113149	Rp 2 1/2	35,0
TFK 300-30	113150	Rp 3	38,0

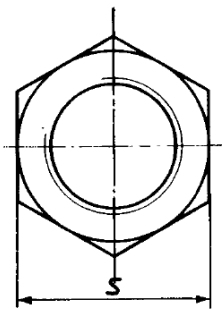

TFG 310-10

Gegenmutter 310, IG

Typen Nr.	Artikel Nr.	Gewinde außen	a min. mm
TFG 310-14	113151	Rp 1/4	6,0
TFG 310-38	113152	Rp 3/8	7,0
TFG 310-12	113153	Rp 1/2	8,0
TFG 310-34	113154	Rp 3/4	9,0
TFG 310-10	113155	Rp 1	10,0
TFG 310-112	113156	Rp 1 1/2	12,0
TFG 310-20	113157	Rp 2	13,0
TFG 310-212	113158	Rp 2 1/2	16,0
TFG 310-30	113159	Rp 3	19,0

*Das Maß s für die Schlüsselweiten hängt von der Konstruktion des Fittings ab und bleibt dem Hersteller überlassen.

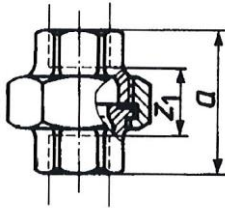

TFV 330-12

Verschraubung 330, flach dichtend, IG/IG, mit NBR-Dichtung (NBR mit Aramidfasern)
 Temperatur-Bereich von -20 °C bis 200 °C

Typen Nr.	Artikel Nr.	Gewinde innen	a mm	z ₁ mm
TFV 330-14-D	113160	Rp/Rp 1/4	42,0	22,0
TFV 330-38-D	113161	Rp/Rp 3/8	45,0	25,0
TFV 330-12-D	113162	Rp/Rp 1/2	48,0	22,0
TFV 330-34-D	113163	Rp/Rp 3/4	52,0	22,0
TFV 330-10-D	113164	Rp/Rp 1	58,0	24,0
TFV 330-114-D	113165	Rp/Rp 1 1/4	65,0	27,0
TFV 330-112-D	113166	Rp/Rp 1 1/2	70,0	32,0
TFV 330-20-D	113167	Rp/Rp 2	78,0	30,0
TFV 330-212-D	113168	Rp/Rp 2 1/2	85,0	31,0
TFV 330-30-D	113169	Rp/Rp 3	95,0	35,0

→ Maximale Temperatur und maximaler Betriebsdruck dürfen nicht gleichzeitig auftreten!

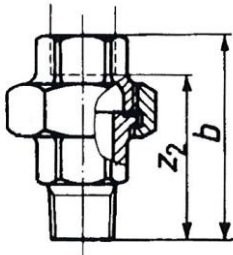

TFV 331-12

Verschraubung 331, flach dichtend, IG/AG, mit NBR-Dichtung (NBR mit Aramidfasern)
Temperatur-Bereich von -20 °C bis 200 °C

Typen Nr.	Artikel Nr.	Gewinde innen	Gewinde außen	b mm	z ₂ mm
TFV 331-14-D	113170	Rp 1/4	R 1/4	55,0	45,0
TFV 331-38-D	113171	Rp 3/8	R 3/8	58,0	48,0
TFV 331-12-D	113172	Rp 1/2	R 1/2	66,0	53,0
TFV 331-34-D	113173	Rp 3/4	R 3/4	72,0	57,0
TFV 331-10-D	113174	Rp 1	R 1	80,0	63,0
TFV 331-114-D	113175	Rp 1 1/4	R 1 1/4	90,0	71,0
TFV 331-112-D	113176	Rp 1 1/2	R 1 1/2	95,0	76,0
TFV 331-20-D	113177	Rp 2	R 2	106,0	82,0
TFV 331-212-D	113178	Rp 2 1/2	R 2 1/2	118,0	91,0

→ Maximale Temperatur und maximaler Betriebsdruck dürfen nicht gleichzeitig auftreten!

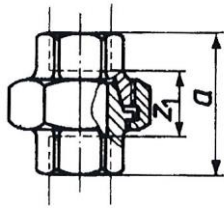

TFV 340-12

Verschraubung 340, konisch dichtend, IG/IG

Typen Nr.	Artikel Nr.	Gewinde innen	a mm	z ₁ mm
TFV 340-14	113179	Rp/Rp 1/4	42,0	22,0
TFV 340-38	113180	Rp/Rp 3/8	45,0	25,0
TFV 340-12	113181	Rp/Rp 1/2	48,0	22,0
TFV 340-34	113182	Rp/Rp 3/4	52,0	22,0
TFV 340-10	113183	Rp/Rp 1	58,0	24,0
TFV 340-114	113184	Rp/Rp 1 1/4	65,0	27,0
TFV 340-112	113185	Rp/Rp 1 1/2	70,0	32,0
TFV 340-20	113186	Rp/Rp 2	78,0	30,0
TFV 340-212	113187	Rp/Rp 2 1/2	85,0	31,0
TFV 340-30	113188	Rp/Rp 3	95,0	35,0

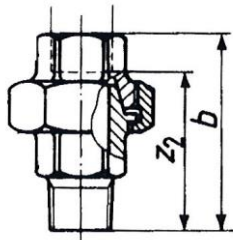

TFV 341-10

Verschraubung 341, konisch dichtend, IG/AG

Typen Nr.	Artikel Nr.	Gewinde innen	Gewinde außen	b mm	z ₂ mm
TFV 341-14	113189	Rp 1/4	R 1/4	55,0	45,0
TFV 341-38	113190	Rp 3/8	R 3/8	58,0	48,0
TFV 341-12	113191	Rp 1/2	R 1/2	66,0	53,0
TFV 341-34	113192	Rp 3/4	R 3/4	72,0	57,0
TFV 341-10	113193	Rp 1	R 1	80,0	63,0
TFV 341-114	113194	Rp 1 1/4	R 1 1/4	90,0	71,0
TFV 341-112	113195	Rp 1 1/2	R 1 1/2	95,0	76,0
TFV 341-20	113196	Rp 2	R 2	106,0	82,0
TFV 341-212	113197	Rp 2 1/2	Rp 2 1/2	118,0	91,0
TFV 341-30	113198	Rp 3	Rp 3	130,0	100,0

Flachdichtung für Tempergussfittings (NBR mit Aramidfasern)

Temperatur-Bereich von -20 °C bis 200 °C

Typen Nr.	Artikel Nr.	für Anschlussgröße (Zoll)	Außen-Ø mm	Innen-Ø mm	Stärke mm
TFD 14-1	162262	1/4	24,0	17,0	2,0
TFD 38	113200	3/8	27,0	19,0	2,0
TFD 12	113201	1/2	30,0	21,0	2,0
TFD 34	113202	3/4	38,0	27,0	2,0
TFD 10	113203	1	44,0	32,0	2,0
TFD 114	113204	1 1/4	55,0	42,0	2,0
TFD 112	113205	1 1/2	62,0	46,0	2,0
TFD 20	113206	2	78,0	60,0	2,0
TFD 212	113207	2 1/2	97,0	75,0	2,0
TFD 30	113208	3	110,0	88,0	2,0



TFD 12

→ Maximale Temperatur und maximaler Betriebsdruck dürfen nicht gleichzeitig auftreten!

Bei den angegebenen Abmessungen handelt es sich um Circa-Maße in mm.

Die Maße der Schlüsselweiten bleiben laut Vorgabe DIN EN 10242 dem Hersteller überlassen und können daher variieren.